

ALTO[®]

CLARKE

TECHNOLOGY

**Operator's
Manual**

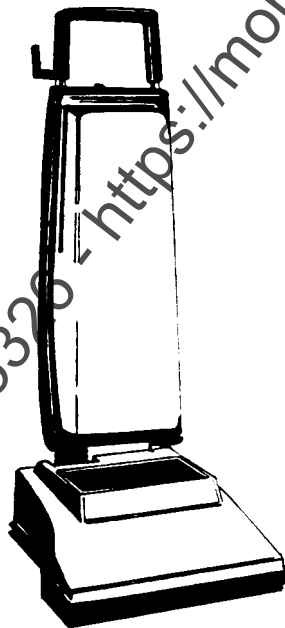

**Model 577
Carpetmaster**

READ THIS BOOK

This book has important information for the use and safe operation of this machine. Failure to read this book prior to operating or attempting any service or maintenance procedure to your ALTO machine could result in injury to you or to other personnel; damage to the machine or to other property could occur as well. You must have training in the operation of this machine before using it. If you or your operator(s) cannot read English, have this manual explained fully before attempting to operate this machine.

Si Ud. o sus operadores no pueden leer el Inglés, se hagan explicar este manual completamente antes de tratar el manejo o servicio de esta máquina.

All directions given in this book are as seen from the operator's position at the rear of the machine.

For new books write to: ALTO U.S. Inc., 2100 Highway 265, Springdale, Arkansas 72764.

TABLE OF CONTENTS



Operator Safety Instructions	6
How to Prepare The Machine For Operation:	
How To Adjust The Brush	2
How To Use Your Machine As A Tank Type Vacuum Cleaner	2
Instructions For Connection To The Power Supply & Electrical Ground	3
Extension Cords	3
How To Operate Your Machine:	
How To Start The Machine	4
How To Stop The Machine	4
Circuit Breaker	4
Maintenance:	
How To Clean The Filter Bags	4
How To Clean The Foam Filter	5
How To Install The Micro-Staphicidal® Filter	5
How To Clean The Micro-Staphicidal® Filter	6
How To Check For Worn Brushes	6
How To Replace The Brush	6
How To Open The Bottom Cover	6
How To Clean The Air Tunnel	7
How To Adjust The Brush Drive Belt	7
How To Remove The Drive Motor	8
Maintenance Of The Vacuum Motor	8
How To Check The Commutator And The Carbon Brushes	8
How To Correct Problems In The Machine	9
Drawings and Parts List:	
Model 577 Wiring Schematic	10
Model 577 Upper-Half Drawing	12
Model 577 Upper-Half Parts List	13
Model 577 Lower-Half Drawing	14
Model 577 Lower-Half Parts List	15









OPERATOR SAFETY INSTRUCTIONS

 **WARNING**

 **AVERTISSEMENT**

 **ADVERTENCIA**

-  **DANGER:** Failure to read and observe all **DANGER** statements could result in severe bodily injury or death. Read and observe all **DANGER** statements found in your Owner's Manual and on your machine.
-  **WARNING:** Failure to read and observe all **WARNING** statements could result in injury to you or to other personnel; property damage could occur as well. Read and observe all **WARNING** statements found in your Owner's Manual and on your machine.
-  **CAUTION:** Failure to read and observe all **CAUTION** statements could result in damage to the machine or to other property. Read and observe all **CAUTION** statements found in our Owner's Manual and on your machine.

-  **DANGER:** Failure to read the Owner's Manual prior to operating or attempting any service or maintenance procedure to your machine could result in injury to you or to other personnel; damage to the machine or to other property could occur as well. You must have training in the operation of this machine before using it. If you or your operator(s) cannot read English, have this manual explained fully before attempting to operate this machine.
-  **DANGER:** Operating a machine that is not completely or fully assembled could result in injury or property damage. Do not operate this machine until it is completely assembled. Inspect the machine carefully before operation. Do not use as a step or furniture, the machine could move causing injury.
-  **DANGER:** Machines can cause an explosion when operated near flammable materials and vapors. Do not use this machine with or near fuels, grain dust, solvents, thinners, or other flammable materials.
-  **DANGER:** Using a machine with a damaged power cord could result in an electrocution. Do not use the machine if the power cord is damaged. To prevent damage to the power cord, do not let the brush touch the power cord when the machine is running. Always lift the power cord over the machine. Do not use the electrical cord to move the machine.
-  **DANGER:** Electrocution could occur if maintenance and repairs are performed on a unit that is not disconnected from the power source. Disconnect the power supply before changing the brush or accessories or attempting any maintenance or service. Maintenance and repairs must be done by authorized personnel.
-  **WARNING:** Operating a machine without observing all labels and instructional information could result in injury or damage. Read all machine labels before attempting to operate. Make sure all of the labels and instructional information are attached or fastened to the machine. Get replacement labels and plates from your Clarke Technology distributor.
-  **WARNING:** Always use a three-wire electrical system connected to the electrical ground. For maximum protection against electric shock, use a circuit that is protected by a ground fault circuit interrupter. Consult your licensed electrician and/or contact your local Clarke Technology distributor for assistance.
-  **WARNING:** To prevent electrical shock, do not use this machine on wet surfaces. Protect the machine from rain, Keep the machine in a dry building. Always clean the machine with a clean dry cloth.

HOW TO PREPARE THE MACHINE FOR OPERATION

WARNING: To prevent electric shock, do not vacuum liquids or wet surfaces with this machine.

The Model 577 has five brush settings (1). The adjustment lever (2) is at the rear of the machine. See Figure 1.

To set the brush height, do the following:

1. Place your foot behind one wheel.

NOTE: Do not push the handle release lever.

2. Pull back on the handle a little.
3. With your other hand, pull the adjustment lever.
4. Put the adjustment lever in the "High" setting.
5. Move the adjustment lever toward the "Low" setting.
6. When the brush comes in contact with the carpet, push the adjustment lever in the detent.

NOTE: Do not set the brush too low. Shag carpets are generally best cleaned by the brush in the highest setting.

CAUTION: Be careful when cleaning long shag, the carpet can go around the brush, and slow or stop the brush.

How To Use Your Machine As A Tank Type Vacuum Cleaner

You can use your Carpetmaster as a tank type vacuum cleaner to clean overhead and hard to reach areas. Get extension tubes, hoses, wands, and attachments from your Clarke Technology dealer.

To attach the accessories to your Carpetmaster, follow this procedure.

1. Pull the black standpipe hose (1) off the standpipe tube (2). The hose is at the lower-right corner of the machine.
2. Slide the hose adapter (3) on the tube.
3. Slide the vacuum hose on the adapter (4). See Figure 2

The accessory switch is on the rear of the housing. To start only the vacuum motor, do the following:

1. Make sure the handle is in the vertical position.
2. Press the "Vac Only Switch." See Figure 3.

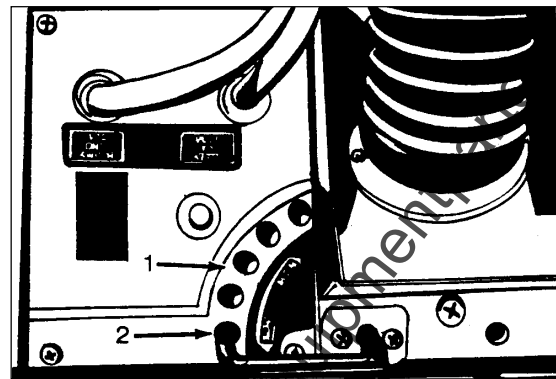

Figure 1

1. Five Brush Settings
2. Adjustment Lever

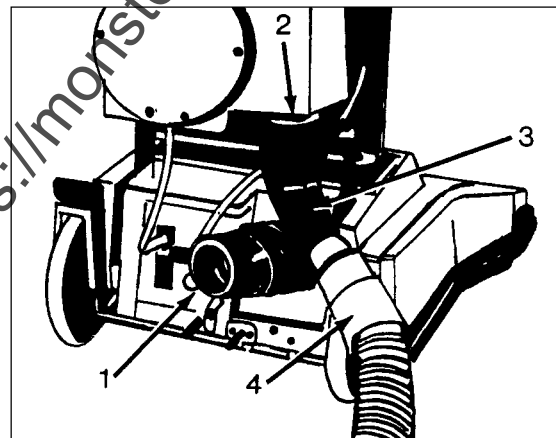

Figure 2

1. Black Standpipe Hose
2. Standpipe Tube
3. Hose Adapter
4. Vacuum Hose

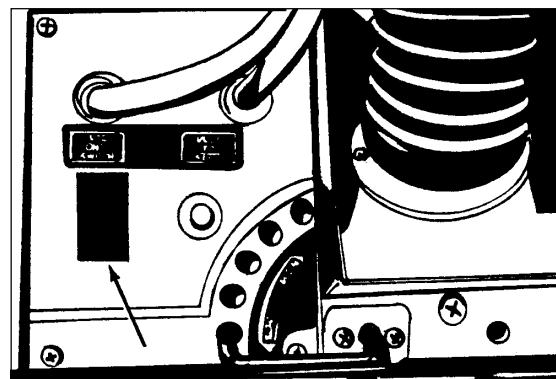

Figure 3

1. "Vac Only" Switch

120 VOLT MACHINES INSTRUCTIONS FOR CONNECTION TO THE POWER SUPPLY AND THE ELECTRICAL GROUND

The machine must be connected to the electrical ground to protect the operator from electric shock. The machine has an approved power cord with three conductors and a plug with three terminals. Connect the plug to a receptacle that has three holes and is connected to the electrical ground. For maximum protection against electric shock, use a circuit that is protected by a ground fault circuit interrupter. The green (or green and yellow) conductor in the cord is the ground wire. Never connect this wire to any terminal other than the ground terminal.

This machine uses a 120 volt AC 60 cycle electrical circuit. Make sure you have the correct frequency and voltage before connecting the power cord to an outlet. The machine has a plug as shown in Figure 4. If a receptacle connected to the electrical ground as shown in Figure 4 is not available, have one installed by an electrical contractor. Do not use an adapter.

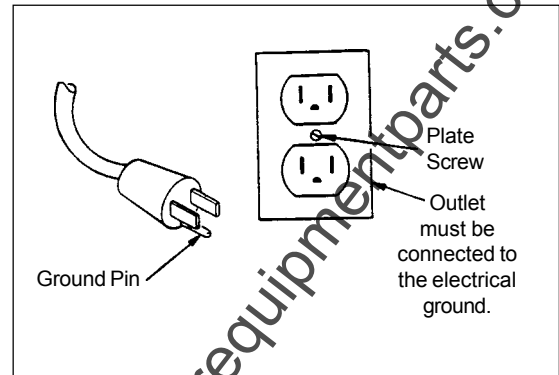

Figure 4

- ⚠ WARNING:** To prevent possible electric shock, protect the machine from rain. Keep the machine in a dry building.
- ⚠ WARNING:** To prevent possible electric shock, always use a 3-wire electrical system connected to the electrical ground. For maximum protection against electrical shock, use a circuit that is protected by a ground fault circuit interrupter. Consult your electrical contractor.
- ⚠ WARNING:** Do not cut, remove or break the ground pin. If the outlet does not fit the plug, consult your electrical contractor.
- ⚠ WARNING:** Have worn, cut, or damaged cords and plugs replaced by an authorized service person.

EXTENSION CORDS

Use only an approved extension cord with three conductors, a plug with three terminals, and a connector body with three holes. The machine has a power cord with wire size 14 AWG (AWG means American Wire Gauge).

- ⚠ WARNING:** If you use an extension cord, use an extension cord with minimum wire size 16 AWG. Do not use an extension cord longer than 50 feet. Do not join two extension cords.

HOW TO OPERATE YOUR MACHINE

How To Start The Machine

The handle release lever is at the lower left rear corner of the machine (1). See Figure 5.

To start the machine, do the following:

1. Using your foot, push the release lever forward (1).
2. Lower the handle.

The vacuum motor and the brush drive motor will start when the handle is lowered. To activate the vacuum motor only, push the "Vac Only Switch," and lower the handle.

NOTE: When using the vacuum motor and the brush drive motor, make sure the "VAC Only Switch" is in the off position.

How To Stop The Machine

To stop the vacuum motor and the brush drive motor, push the handle to the upright position.

Circuit Breaker

The Model 577 has a circuit breaker. If there is an obstruction in the machine, the brush drive motor will stop. To restart the motor, follow this procedure:

1. Make sure the handle is in the upright position.
2. Remove the electrical plug from the electrical outlet.
3. Put the machine on its side so that the right side is up.
4. If there is an obstruction, remove the obstruction.
5. Put the machine in the upright position.
6. Put the electrical plug in the electrical outlet.
7. The reset button is at the lower rear of the machine. Push the reset button. See figure 6

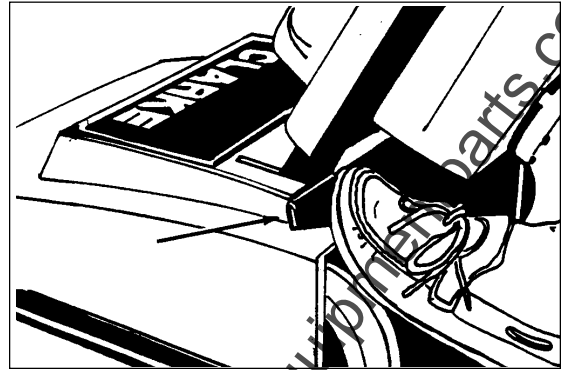

Figure 5
1. Release Lever

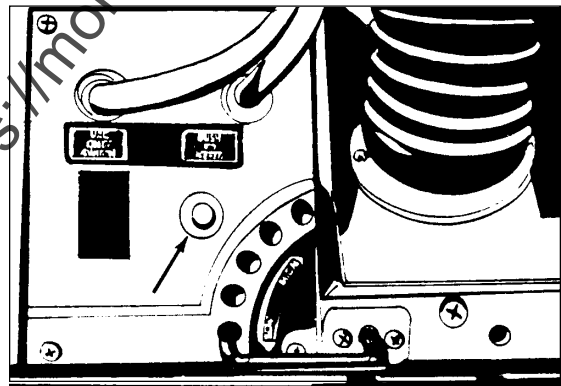

Figure 6
1. Circuit Breaker Reset Button

MAINTENANCE

This section describes the procedures that must be done by a person authorized to do maintenance.

WARNING: To prevent electric shock, always remove the electrical plug from the electrical outlet before doing any repairs or maintenance to this machine.

How To Clean And Install The Filter Bag

WARNING: Do not put a filter bag in an incinerator or fire. It could cause injury to the operator by causing a fire.

Maintenance

How To Clean and Install The Filter Bag (cont)

CAUTION: Do not operate this machine unless a filter bag is in position. It could damage the vacuum motor.

When replacing the paper filter bags, follow this procedure:

1. When the bag is $\frac{3}{4}$ full, open the tank by pushing the knob (1) on top of the tank. See figure 7
2. Lift out and discard the used bag.
3. Unfold a new paper bag.
4. Hold the bag by the cardboard inlet tab (2).
5. Slide the inlet over the standpipe (3). Do not apply pressure to the back of the bag.
6. Close the front cover.

When cleaning the cloth filter bag, follow this procedure:

1. When the bag is $\frac{3}{4}$ full, open the tank by pushing the knob on top of the tank.
2. Pull out the cloth bag.
3. Slide off the clip.
4. Remove the dirt from the bag.
5. Sweep the inside surface of the bag to remove the remaining dirt.
6. When the bag is clean, fasten the clip.
7. Slide the inlet seal over the standpipe.
8. Close the front cover.

How To Clean The Foam Filter

A foam filter is on the base of the vacuum motor. See figure 8. The filter helps to prevent dust and debris from entering the vacuum motor. Wash the foam filter every week. To remove the filter, slide it off the motor housing.

CAUTION: Make sure the foam filter is completely dry before you install it. Moisture will damage the vacuum motor.

How To Install The Micro-Staphicidal® Filter

The Micro-Staphicidal filter is offered as optional equipment. Use the Micro-Staphicidal filter with the cloth filter or the paper filter. To install the Micro-Staphicidal filter, follow this procedure:

1. Open the tank by pushing the knob on top of the tank.
2. Remove the foam filter from the base of the machine.
3. Make sure the cloth bag or the paper filter bag is in position.
4. Push the Micro-Staphicidal filter on the base of the motor. See figure 9.
5. Close the front cover.

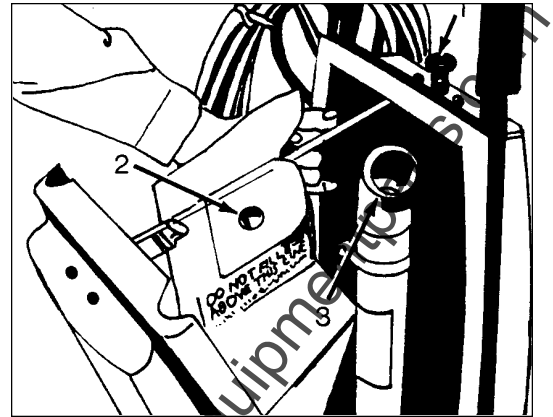

Figure 7

1. Knob
2. Inlet
3. Standpipe

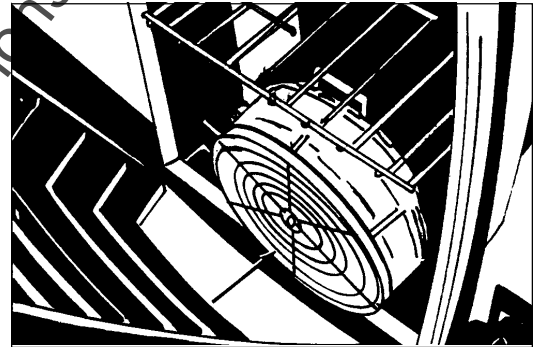

Figure 8

1. Foam Filter

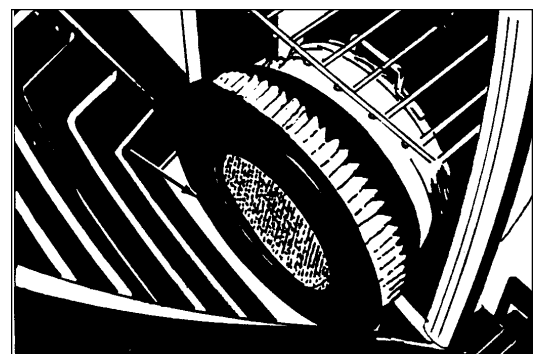

Figure 9

1. Micro-Staphicidal® Filter

The Micro-Staphicidal filter will trap minute airborne particles down to .3 microns in size. The filter traps the bacteria, it does not kill the bacteria. Clean the filter at least once a month. To clean the Micro-Staphicidal filter, follow this procedure:

1. Remove the filter.
2. Tap the filter against a hard surface.
3. Blow or vacuum the loose dirt from the filter.

If the filter is not clean after doing the above, do the following:

1. Wash or soak the filter in a detergent and water solution.

CAUTION: Do not wash or soak the filter more than five minutes.

2. Remove the filter from the solution.
3. Rinse the filter with clean water.
4. Dry the filter thoroughly.

The Micro-Staphicidal filter should be replaced after six months of use.

How To Check For Worn Brushes

To check for worn brushes, follow this procedure:

1. Put the machine on its side so that the right side is up.
2. Check the bristles, make sure the bristles are not shorter than 5/16 inch. See figure 10
3. If the bristles are shorter than 5.16 inch, replace the brush.

How to Replace The Brush

The brush has a chevron design. The brush has two halves fastened to a steel tube by screws. To remove the worn brushes, do the following:

1. Remove the three screws from each half. See figure 11.
2. When installing the brush halves, make sure the center of each half of the brush points to the front of the machine when seen from the bottom.
3. Tighten the three screws from each half.
4. Always replace both halves of the brush.

How To Open The Bottom Cover

The bottom of your Carpetmaster® has a cover which is also a mounting plate for the front swivel casters. Open the cover to get access to the brush drive motor, belt, switches, and the air tunnel. The release lever is at the rear of the machine.

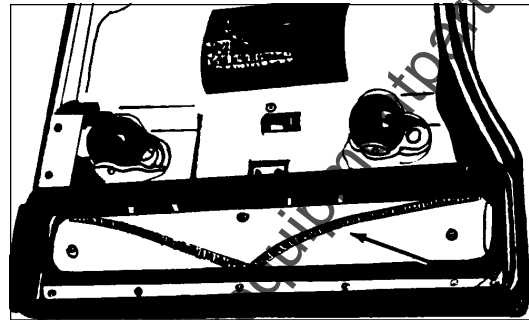

Figure 10
1. Brush Bristles

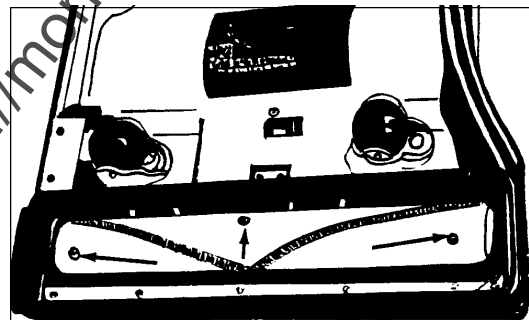

Figure 11
1. Brush Screws

To open the cover, follow this procedure:

1. Remove the electrical plug from the electrical outlet.
2. Put the machine on its side so that the right side is up.
3. Remove the screw.
4. Pull the lever (1) and turn it clockwise to release the cover.
5. Put the rod in the detent opposite the five brush setting holes (2). See figure 12

How To Clean The Air Tunnel

The air tunnel cover is located on the bottom of the machine. To clean the air tunnel, follow this procedure:

1. Lift the tunnel clamp (1).
2. Remove the cover (2).
3. Remove the object or debris.
4. Put the cover in position.
5. Push the tunnel clamp down. See figure 13

How To Adjust The Brush Drive Belt

To adjust the tension of the belt to drive the brush, use this procedure:

1. Loosen the four screws that hold the motor.
2. Move the motor toward the front of the machine to loosen the belt. Move the motor toward the back of the machine to tighten the belt.
3. The tension of the belt is correct when you can push the belt 1/8 inch to 3/16 inch at the belt guard (14 lbs. pressure if you use a belt tension gauge).
4. Tighten the four screws that hold the motor.

Turn the belt by hand to make sure the belt is aligned on the pulleys. To adjust the alignment of the belt, use this procedure:

1. Loosen the two set screws on the pulley on the motor.
2. Move the pulley to the left or to the right.
3. Tighten the two set screws.

To put the machine back in operation, follow this procedure:

1. Close the bottom cover.
2. Move the brush adjustment lever to one of the five brush height settings.
3. Push the lever in the setting detent.
4. Set the machine upright. Make sure the handle is in the vertical position.



WARNING Do not operate this machine unless it is fully assembled. The machine could be damaged or injury could occur to the operator

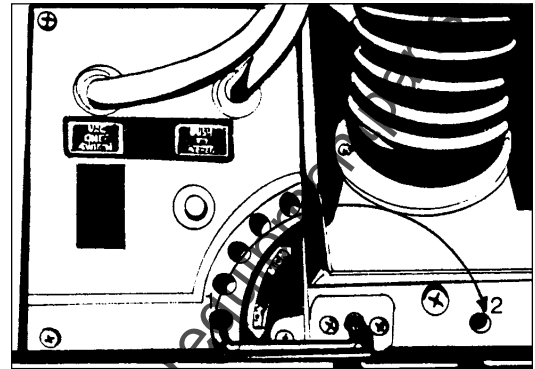

Figure 12

1. Lever
2. Bottom Right Side Detent

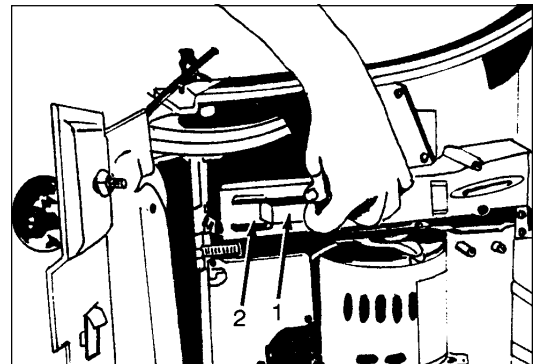

Figure 13

1. Tunnel Clamp
2. Tunnel Cover

How To Remove The Drive Motor

The motor to drive the brush needs no preventive maintenance. If the motor must be replaced, follow this procedure:

1. Remove the four mounting screws (1). See figure 14
2. Lift the motor to remove the two screws from the motor plate.
3. Disconnect the six spade connectors.
4. Remove the motor from the machine.

Maintenance Of The Vacuum Motor

This machine uses a universal motor that has a commutator and carbon brushes. The commutator and carbon brushes must be checked every six months, or 600 hours of operation, whichever comes first.

WARNING: Electrical inspections must be made by a person authorized to do maintenance. Electrical repairs must be made by a person authorized to make electrical repairs.

WARNING: To prevent electrical shock, always remove the electrical plug from the electrical outlet before doing any repairs or maintenance to this machine.

How To Check The Commutator and The Carbon Brushes

To check the commutator and the carbon brushes, follow this procedure:

1. Remove the screws that hold the motor baffle. The motor baffle is at the rear of the machine.
2. Remove the baffle.
3. Remove the wire clip mounting screw and the grounding mounting screw.
4. Remove the wire nuts.
5. Remove the vacuum motor mounting screws.
6. Remove the motor from the tank.
7. Inspect the commutator. Take the machine to a Clarke Technology Authorized Repair Location if you see any of the following conditions:
 - a. Small holes in the surface of the commutator. See figure 15A
 - b. Uneven color. Look for an even dark brown color. Clean areas or very dark areas indicate a problem. See figure 15B
 - c. High mica. The mica insulation must be lower than the commutator bars. See figure 15C
8. Remove the carbon brush assemblies and check the carbon brushes. Replace both carbon brush assemblies if either brush is shorter than 3/8 inch. If either brush is shorter than 1/2 inch, order replacement brushes. Be ready to replace both carbon brushes earlier than the normal inspection time.
9. Install the motor, the motor baffle, and the fasteners.

WARNING: The machine must be tested for electrical safety after electrical repairs are made.

NOTE: For safe operation have your machine checked by a Clarke Technology Authorized Repair Person every 12 months. Always use Clarke Technology replacement parts.

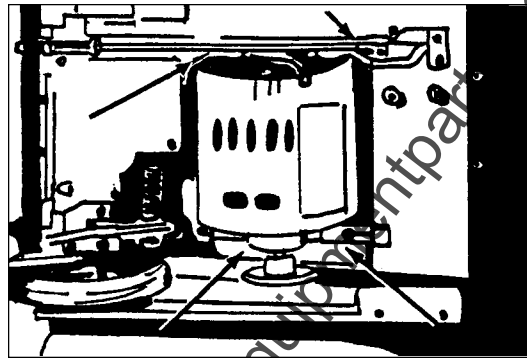

Figure 14
1. Mounting Screws

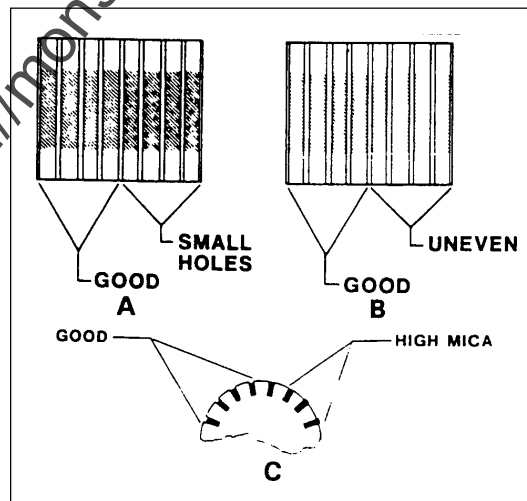
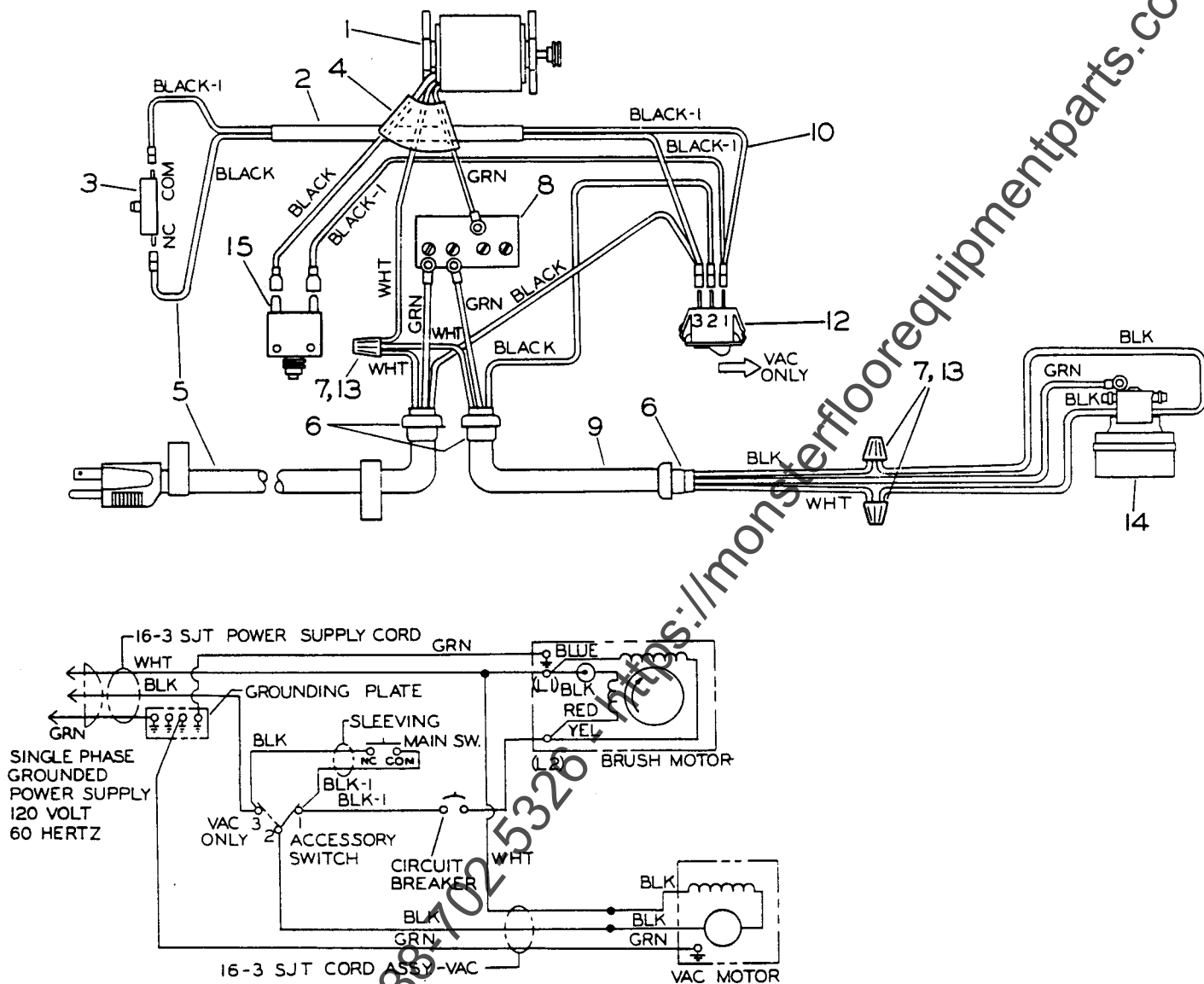

Figure 15

HOW TO CORRECT PROBLEMS IN THE MACHINE

PROBLEM	CAUSE	ACTION
The machine does not run.	1. There is no power	<ol style="list-style-type: none"> 1. There is an obstruction. See "Circuit Breaker" in the manual. 2. The electrical outlet, power cord, electrical switches and motor brushes are to be checked. Electrical inspections must be made by a person authorized to do maintenance. Electrical repairs must be made by a person authorized to make electrical repairs.
The machine does not remove debris from the floor.	1. The filter bag is dirty.	<ol style="list-style-type: none"> 1. If the bag is $\frac{3}{4}$ full, discard the paper bag. Clean the bag if it is a cloth bag. If the machine is used to pick up heavy debris, discard or clean the bag before it is $\frac{3}{4}$ full.
	2. There is an obstruction in the standpipe.	<ol style="list-style-type: none"> 1. Remove the hose from the standpipe tube. 2. Start the vacuum motor. 3. Hold your hand over the standpipe tube. If you feel no suction, the standpipe has an object in it. 4. Shut off the vacuum motor. 5. Remove the object.
	3. There is an obstruction in the hose.	<ol style="list-style-type: none"> 1. Remove the hose from the standpipe tube. 2. Remove the obstruction.
	4. There is an obstruction in the air tunnel.	<ol style="list-style-type: none"> 1. Check the air tunnel. 2. Replace the gasket if it is worn or broken.
	5. The tank gasket is worn or broken.	<ol style="list-style-type: none"> 1. Check the entire gasket (top, bottom, and sides) where the front tank seals against the rear tank. 2. Replace the gasket if it is worn or broken.
	6. The brush does not turn clockwise when seen from the right-hand side of the machine.	<ol style="list-style-type: none"> 1. Return the machine to a Clarke Service Branch or a Clarke Technology Service Center to have the motor wired correctly.
	7. The brush setting is not correct.	<ol style="list-style-type: none"> 1. Change the brush setting. If the brush is set too low on a deep pile carpet, the housing can stop the air flow.
	8. The brush is worn. 9. The foam filter is dirty.	<ol style="list-style-type: none"> 1. Replace the brush. 1. Clean the foam filter.
The brush does not rotate.	1. There is an obstruction in the brush housing.	<ol style="list-style-type: none"> 1. Remove the obstruction.
	2. There is an obstruction in the bearings on the end of the brush.	<ol style="list-style-type: none"> 1. Remove the obstruction.
	3. The belt is broken or loose.	<ol style="list-style-type: none"> 1. Replace or tighten the belt.
	4. There is low line voltage.	<ol style="list-style-type: none"> 1. Remove other appliances on the line or provide a separate circuit.
	5. The brush drive motor will not run.	<ol style="list-style-type: none"> 1. Push the circuit breaker button.

CLARKE TECHNOLOGY
Model 577 Upright Vacuum
Wiring Diagram & Schematic 8/98



Ref	Part No.	Description	Qty
1	44606A	Motor Asm) - Brush ¼HP 120V	1
	44602A	Motor Asm. - Brush ¼HP 220V	1
2	48500A	Tubing	1
3	911562	Switch (Main)	1
4	609407	Tubing	1
5 u	42186B	Cord Asm. (Power Supply)	1
6	657501	Strain Relief	3
7	911413	Wire Nut	3
8	606440	Plate, Grounding	1
9 u	41954A	Cord Asm. (Vac Motor)	1

Ref	Part No.	Description	Qty
10	912294	Lead Asm.	1
11			
12	912262	Switch - Accessory	1
13	990716	Tape - Electrical	1
14	44900A	Motor - Vac 120V	1
	44901A	Motor - Vac 220V	1
15	912263	Circuit Breaker, 120V	1
	912270	Circuit Breaker, 220V	1

NOTE:

indicates a change has been made since last publication of this manual.

CAUTION: Repairs by qualified personnel only.
ARHTUNG: Reparaturen nur durch facharbeiter.
PRECAUCION: Reparaturen par personal specialise seulement.
PRECAUCION: Unicamente personal calificado deberian hacer reparaciones.

Notes

To Order Parts Call 1-888-702-5326 - <https://monsterfloorequipmentparts.com>

CLARKE TECHNOLOGY
 Model 577 Upright Vacuum
 Drawing Upper Half 3/00

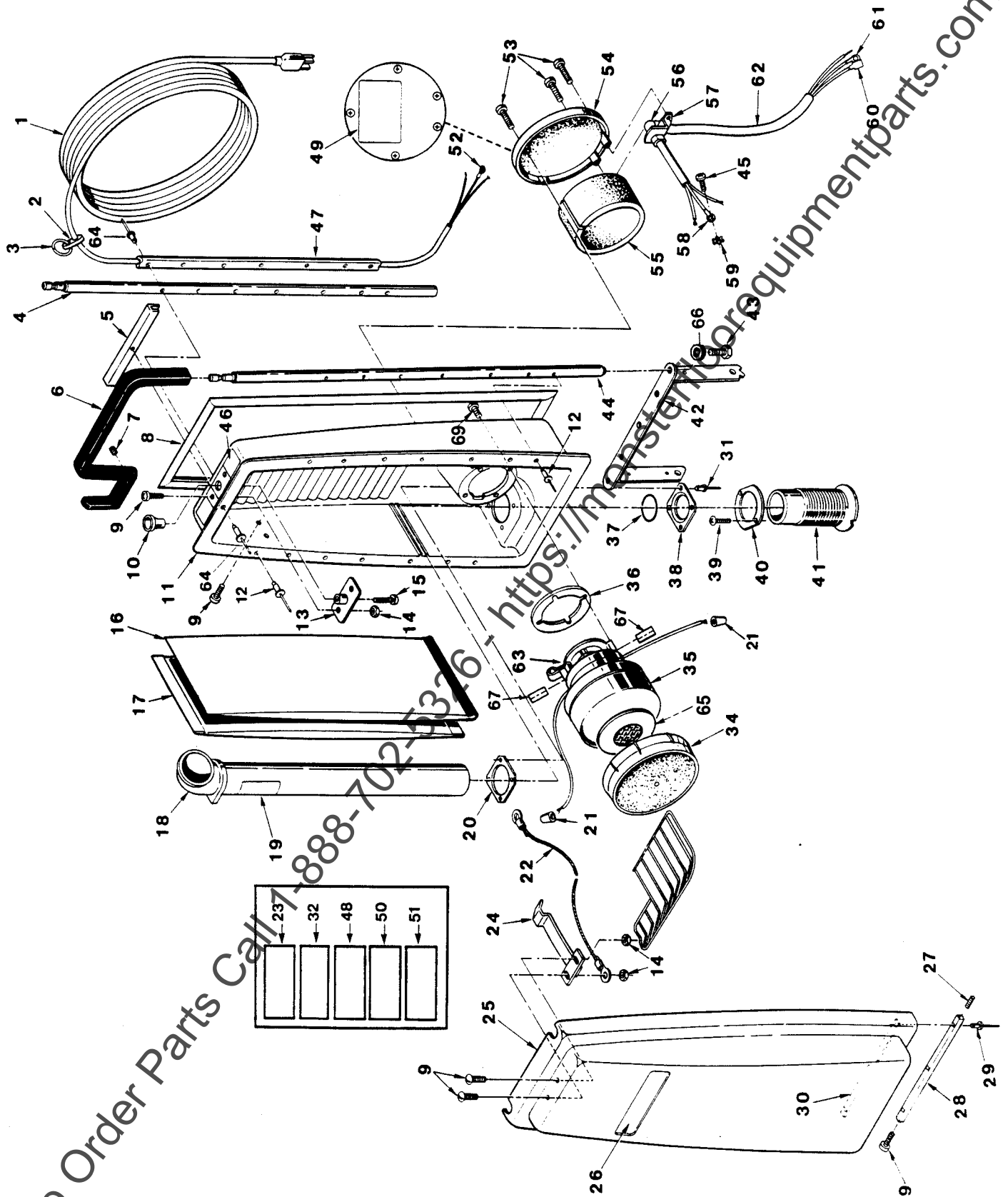

CLARKE TECHNOLOGY
Model 577 Upright Vacuum
Parts List Upper Half 3/00

Ref #	Part No.	Description	Qty
1	42186B	Cord Assembly, Power	1
2	604040	Holder, handle cord	1
3	607340	Ring Split	1
4	609041	Tube Asm., Handle RH	1
5	33500A	Filler, Tank Flange	1
6	603940	Handle	1
7	962965	Screw, 10-24 x ⁵ / ₁₆ Set	2
8	603443	Gasket, Tank	1
9 ♦	962968	Screw 10-24 x 1/2 Pan Hd	7
10	875072	Knob	1
11	38902B	Tank, Rear	1
12	930113	Rivet, Pop 1/8 Dia. Open End	14
13	602440	Catch, Latch	1
14	920200	Nut, 10-24 Hex Hd.	4
15	86100A	Screw 10-24 x 1 3/8 Soc. Hd.	1
16	60700A	Bag, Cloth	1
17	600641	Bag, Paper (Pkg. of 6)	1
18	39300A	Tube, Standpipe	1
19	625184	Label	1
20	623380	Flange, Backup	1
21	911413	Nut, Wire	2
22	602442	Cord, Asm., Nylon	1
23	215104	Label, Warning	1
24	65500A	Latch, Tank	1
25	30003A	Tank, Front	1
26 ♦	77378A	Label, Clarke Technology	1
27	925546	Pin, ³ / ₁₆ x 1/2 Roll	1
28	66100A	Pivot, Front Tank	1
29	930120	Rivet, 1/8 Dia Pop	3
30	601340	Backup, Tank Lower	1
31	930077	Rivet, 1/8 x .482 Lg. Cl. End	4
32	73273A	Label, Warning, Electric Shock	1
33	67303A	Shelf, Bag Support	1
34	623382	Filter, Vac Car	1
35	44900A	Motor, Vacuum (120V)	1
	44901A	Motor, Vacuum (220V)	1

Ref #	Part No.	Description	Qty
36	623443	Gasket, Vacuum Motor	1
37	627680	Seal, O'Ring	1
38	603341	Flange, Retainer	1
39 ♦	85517A	Screw, 10-24 x 1/2	2
40	602041	Clamp, Hose	1
41	604140	Hose, Standpipe	1
42	61200A	Bracket, Asm., Pivot	1
43	85810A	Screw ⁵ / ₁₆ - 18 x ⁵ / ₈	2
44	609040	Tube, Asm., Handle LH	1
45 ♦	962546	Screw 10-24 x 1/2 Rd. Hd.	2
46	605147	Label, Tank Latch	1
47	607245	Retainer, Cord	1
48	705134	Label, Warning (Canada)	1
49	805151	Label, Exhaust Baffle	1
50	215103	Label, Caution	1
51	215110	Label, Caution, Spanish	1
52	911926	Terminal, Clip #6	1
53	962970	Screw 10-16 x 1 1/4	5
54	60004A	Baffle, Asm., Exhaust	1
55	37000A	Pad, Noise	1
56	657501	Strain, Relief	1
57	600854	Bracket, Bushing	1
58	912064	Terminal Clip, #10	1
59	980603	Washer, #SH 1110	1
60	911262	Terminal, Female	1
61	911927	Clip, Terminal	1
62	41954A	Cord Asm., Vac Motor	1
63	872102	Clip, ⁵ / ₁₆ Dia. Nylon	1
64	930108	Rivet, 1/8 Diameter Lg. Fl.	8
65	603642	Guard, Vac Motor Fan	1
66	980652	Washer, ⁵ / ₁₆ Lock	2
67	51419A	Brush, Carton (2 Pack)	1
68	962161	Screw, 10-24 x ³ / ₈	1
69 ♦	962900	Screw, 10-16 x ⁵ / ₈	4

NOTE: ♦ indicates a change has been made since last publication of this manual.

CLARKE TECHNOLOGY
Model 577 Upright Vacuum
Drawing Lower Half 3/00

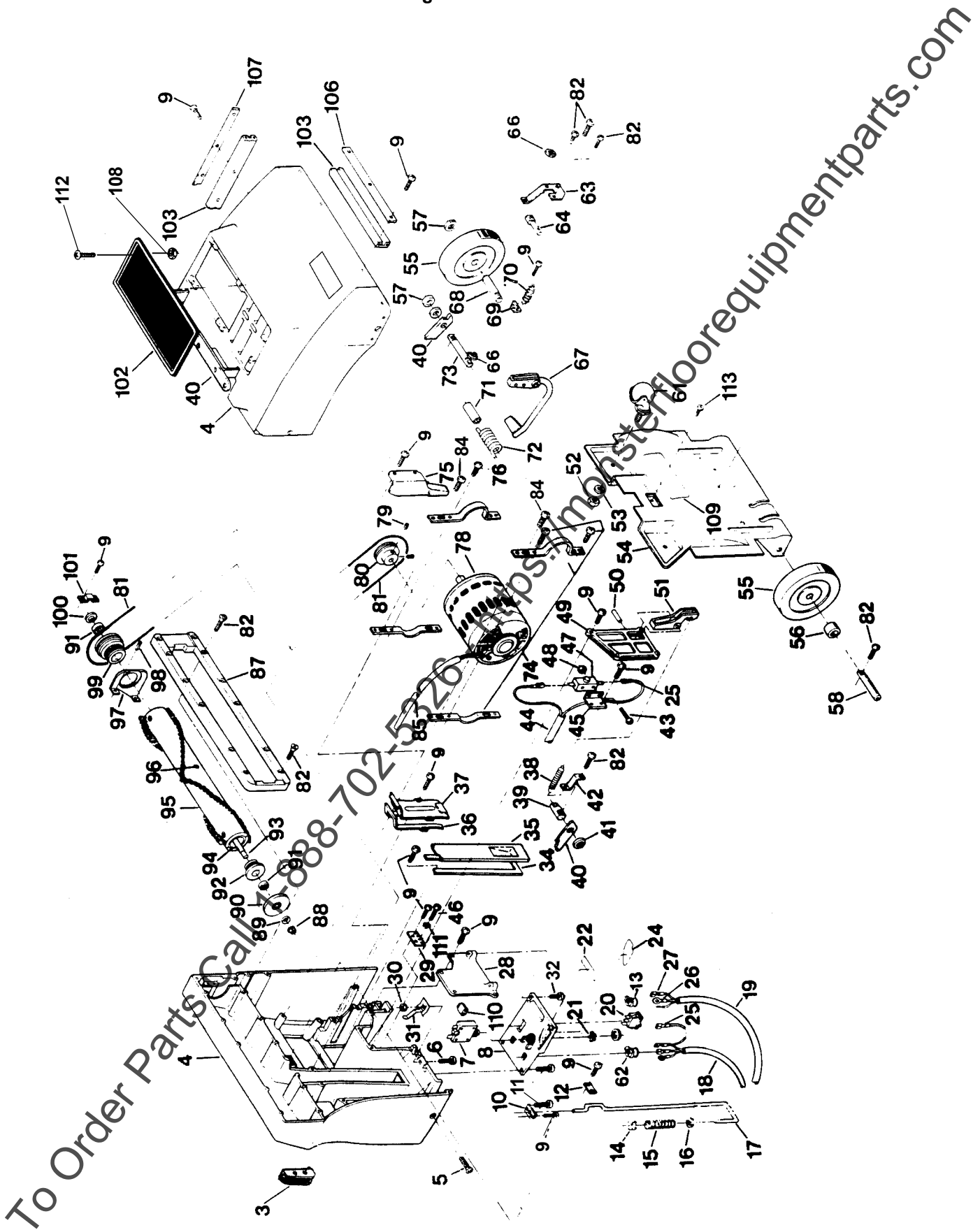

**CLARKE TECHNOLOGY Model 577 Upright Vacuum
Parts List Lower Half 3/00**

Ref#	Part No.	Description	Qty	Ref#	Part No.	Description	Qty
1				58	607041	Pivot, Wheel Right Hand	1
2				59	NI	Plate, Model & Serial (120V)	1
3	617522	Roller Asm. - Side	1		NI	Plate, Model & Serial (220V)	1
4	24526B	Frame - Main	1	60			
5	962968	Screw - #10-24 x 1/2 Pn	2	61	629770	Caster	2
6 ♦	962041	Screw - #10-24 x 7/16 Pan	2	62	46712A	Strain Relief	1
7	912263	Circuit Breaker 120V	1	63	61007A	Brace, Lever Assembly	1
	912270	Circuit Breaker 220V	1	64	607741	Shaft, Lever Release	1
8	32334B	Cover, Electrical	1	65			
9	85517A	Screw 10-24 x 1/2	38	66	920110	Nut, ESNA	2
10 ♦	61196B	Plate, Cam Rod	1	67	16701A	Lever, Assembly, Release	1
11 ♦	962954	Screw #8-18 x 1/2	1	68	607040	Pivot, Wheel Left Hand	1
12	612050	Clamp	1	69	610853	Bracket, Spring	1
13	657501	Relief, Strain	2	70	608340	Spring	1
14	608245	Spacer, Cam Rod	1	71	621181	Bushing, Pivot	1
15	628382	Spring, Rod Return	1	72	628380	Spring	1
16	980646	Washer 1/4 Plain	1	73	66140A	Pivot, Tank Assembly	1
17	67100A	Rod, Cam	1	74	62089	Bracket, Assembly, Motor	2
18	42186B	Cord Assembly, Power	1	75	603641	Guard, Belt	1
19	41954A	Cord Asm., Vac Motor	1	76	962027	Screw 8-32 x 1/2 Rd. Hd.	4
20	912262	Switch	1	77			
21	980407	Washer, Shakeproof	1	78	44606A	Motor, Brush Drive (120V)	1
22	605143	Label, Rear Cover	1		44602A	Motor, Brush Drive (220V)	1
23				79	962165	Screw 10-24 x 3/16 St	2
24	605145	Label, Brush Adjustment	1	80	616950	Pulley, Driver	1
25	911208	Terminal, Clip	1	81	903042	Belt	1
26	911927	Terminal, Ring Tongue	1	82 ♦	85603A	Screw 10-24 x 1 1/4	18
27	911262	Terminal, Clip	1	83			
28	602341	Cover, Bottom Electrical	1	84 ♦	962677	Screw, 10-24 x 3/4	4
29	606440	Plate, Grounding	1	85	609047	Tubing, Electrical	1
30	920200	Nut #10-24 Hex	1	86			
31	602040	Clamp, Tunnel	1	87	38504A	Shoe	1
32 ♦	962957	Screw 10-16 x 1/2	1	88	621182	Bushing, Shaft	1
33				89	980442	Washer, Wave	1
34	603441	Gasket, Tray	1	90	623681	Guard, Thread	1
35	68300A	Tray Asm., Cleanout	1	91	902648	Bearing	2
36	603440	Gasket, Inlet Cover	1	92	626671	Plate, End	1
37	602345	Cover, Inlet	1	93	627770	Shaft, Brush	1
38	628383	Spring	1	94	629070	Tube, Brush	1
39	607044	Pivot, Tank Assembly	1	95	620970	Brush, Half (Set of 2)	1
40	61200A	Bracket Assembly, Pivot	1	96	962821	Screw 8 x 5/8 Flat Head	6
41	980091	Washer, Thrust	1	97	607640	Seal, Brush End	1
42	600842	Bracket, Spring Mounting	1	98	925589	Pin 1/8 x 1/2 Roll	2
43	962212	Screw 6-32 x 7/8 Pn	2	99	606943	Pulley, Driven	1
44	48500A	Tubing, Electrical	1	100	623680	Guard, Thread	1
45	600841	Bracket, Switch Mounting	1	101	607246	Retainer, Brush Shaft	1
46	962970	Screw, 6-32 x 1/2 Pan	3	102 ♦	60019A	Plate, Label	1
47	911562	Switch, cherry	1	103	31200A	Bumper	1
48	920056	Nut 6-32 ESNA	2	104			
49	602342	Cover, Switch	1	105			
50	925062	Pin, 3/16 Spiral	1	106	607240	Retainer, Bumper Front	1
51	605140	Lever, Switch	1	107	607247	Retainer, Bumper Left Hand	1
52	920256	Nut 5/16 -18 Hex	2	108 ♦	920296	Nut 10-24 Elastic Stop	6
53	980652	Washer 5/16 Lock	2	109	605146	Label, Bottom Cover	1
54	61181A	Bracket, Cover & Caster	1	110	672412	Connector, Wire (220 volt)	1
55	629780	Wheel	2	111	980607	Washer #1106 Shakeproof	4
56	38700A	Spacer, Wheel	1	112 ♦	85381A	Screw, 10-24 x 3/4	6
57	38701A	Spacer, Wheel	4	113 ♦	962987	Screw 10-24 x 3/8 Pan	1

NOTE:
♦ indicates a change has taken place since last publication of this manual.

To Order Parts Call 1-888-702-5326 - <https://monstertools.com/monstertools.com>

NOTE

To Order Parts Call 1-888-702-5326 - <https://monsterfloorequipmentparts.com>

ALTO® PRODUCT SUPPORT BRANCHES

U. S. A. Locations

HEAD OFFICE

ALTO U.S. Inc., St. Louis, Missouri
16253 Swingley Ridge Road, Suite 200
Chesterfield, Missouri 63017-1725

PRODUCTION FACILITIES

ALTO U.S. Inc., Springdale, Arkansas
2100 Highway 265
Springdale, Arkansas 72764
(501) 750-1000

Customer Service - 1-800-253-0367

Technical Service - 1-800-356-7274

ALTO U.S. Inc., Bowling Green, Ohio 43402
1100 Haskins

SERVICE FACILITIES

ALTO U.S. Inc., Carlstadt, New Jersey 07072
150 Commerce Road
(201) 460-4774

ALTO U.S. Inc., Elk Grove, Illinois 60007
2280 Elmhurst Road
(847) 956-7900

ALTO U.S. Inc., Denver, Colorado 80204
1955 West 13th Ave.
(303) 623-4367

ALTO U.S. Inc., Houston, Texas 77040
7215 North Gessner Road

SALES AND SERVICE FACILITIES

ALTO U.S. Inc., Madison Heights, Michigan 48071-0158
29815 John R.
(810) 544-6300

ALTO U.S. Inc., Marietta, Georgia 30062
1355 West Oak Common Lane
(770) 973-5225

CLARKE TECHNOLOGY
AMERICAN SANDERS TECHNOLOGY
A.L. COOK TECHNOLOGY
Customer Service Headquarters and Factory

2100 Highway 265
Springdale, Arkansas 72764
(501) 750-1000

Technical Service
1-800-356-7274

European Locations

PRODUCTION FACILITIES

ALTO Danmark A/S, Aalborg
Blytaekervej 2
DK-9000 Aalborg
+45 72 18 21 00

ALTO Danmark A/S, Hadsund
Industrikvarteret
DK-9560 Hadsund
+45 72 18 21 00

SALES SUBSIDIARIES

ALTO Canada Ltd., Rexdale Ontario
24 Constellation Ct.
(416) 675-5830

ALTO Overseas Inc., Sydney (Australia)
1B/8 Resolution Drive
Caringbah NSW 2229
+61 2 9524 6122

ALTO Cleaning Systems Asia Pte Ltd., Singapore
No. 17 Link Road
Singapore 619034
+65 268 1006

ALTO Deutschland GmbH, Bellenberg (Germany)
Guido-Oberdorfer-Straße 2-8
89287 Bellenberg
+49 0180 5 37 37 37

ALTO Cleaning Systems (UK) Ltd., Penrith
Gilwilly Industrial Estate
Penrith
Cumbria CA11 9BN
+44 1768 868 995

ALTO France S.A. Strasbourg
B.P. 44, 4 Place d'Ostwald
F-67036 Strasbourg
Cedex 2
+33 3 8828 8400

ALTO Nederland B.V. Vianen
Stuartweg 4C
NL-4131 NJ Vianen
+31 347 324000

ALTO Sverige AB, Molndal (Sweden)
Aminogatan 18
Box 4029
S-431 04 Molndal
+46 31 706 73 00

ALTO Norge A/S, Oslo (Norway)
Bjornerudveien 24
N-1266
+47 2275 1770

To Order Parts Call 1-888-702-5326 - <https://monster.com/equipmentparts.com>

CLARKE TECHNOLOGY WARRANTY

This Clarke Technology Industrial/Commercial Product is warranted to be free from defects in materials and workmanship under normal use and service for a period of one year from the date of purchase, when operated and maintained in accordance with Clarke Technology's Maintenance and Operations Instructions.

This warranty is extended only to the original purchaser for use of the product. It does not cover normal wear parts such as electrical cable, rubber parts, hoses, bearings, casters, and belts.

If difficulty develops with the product, you should:

- (a). Contact the nearest authorized Clarke Technology repair location or contact the Clarke Technology Service Operations Department, 2100 Highway 265, Springdale, Arkansas 72764, for the nearest authorized Clarke Technology repair location. Only these locations are authorized to make repairs to the product under this warranty.
- (b). Return the product to the nearest Clarke Technology repair location. Transportation charges to and from the repair location must be prepaid by the purchaser.
- (c). Clarke Technology will repair the product and or replace any defective parts without charge within a reasonable time after receipt of the product.

Clarke Technology's liability under this warranty is limited to repair of the product and/or replacement of parts and is given to purchaser in lieu of all other remedies, including INCIDENTAL AND CONSEQUENTIAL DAMAGES.

THERE ARE NO EXPRESS WARRANTIES OTHER THAN THOSE SPECIFIED HEREIN. THERE ARE NO WARRANTIES WHICH EXTEND BEYOND THE DESCRIPTION OF THE FACE HEREOF. NO WARRANTIES, INCLUDING BUT NOT LIMITED TO WARRANTY OF MERCHANTABILITY, SHALL BE IMPLIED. A warranty registration card is provided with your Clarke Technology product. Return the card to assist Clarke Technology in providing the performance you expect from your new floor machine.

ALTO U.S. Inc., 2100 Highway 265, Springdale, Arkansas 72764

CLARKE TECHNOLOGY reserves the right to make changes or improvements to its machine without notice.

Always use genuine Clarke Technology Parts for repair.



CLARKE TECHNOLOGY
2100 Highway 265
Springdale, Arkansas, 72764

To Order Parts Call 1-888-702-5326 - <https://monster10equipmentparts.com>